

由 Autodesk 教育版产品制作

型号

EE-1006

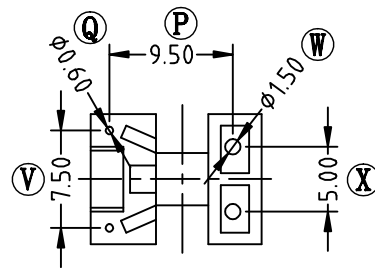
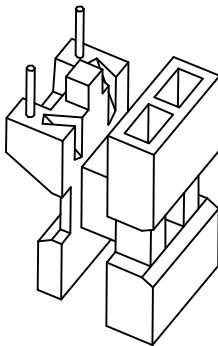
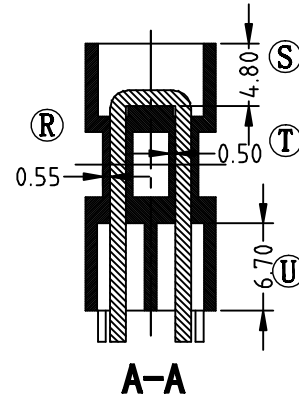
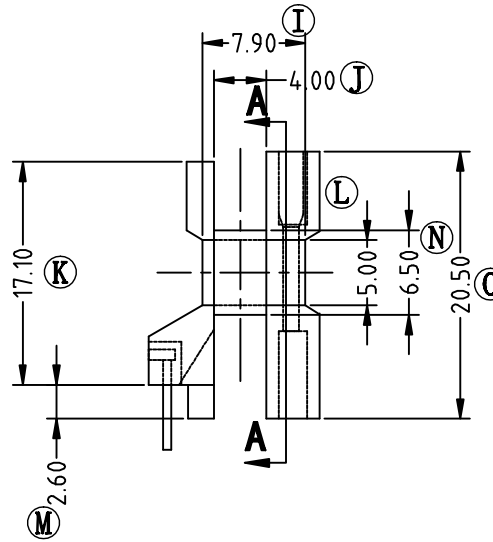
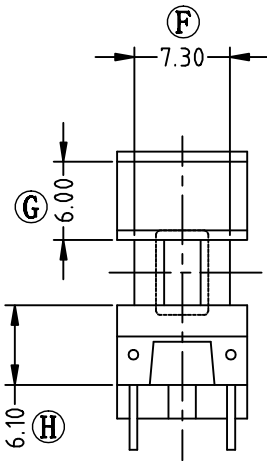
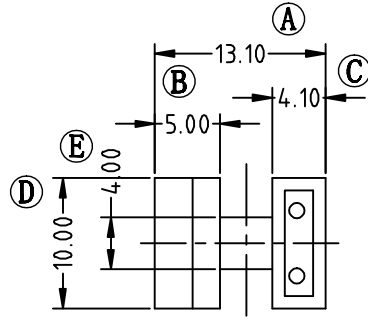
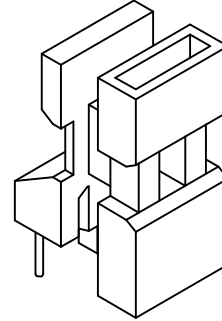

深圳市金辉鼎电子科技有限公司

地址: 深圳市公明街道将石社区油麻岗19号

0755-27658768 传真 0755-27646486

ANGLE:
+/-1°

MODEL NAME:
EE10互感器

UNIT:
mm

UL RECOGNITION:
UL 94V-0

BOBBIN MATERIAL:
PET

DRAFTER 刘金

TOLERANCES

SCALE:
4/1

PIN TEN LOAD:
1.0 Kg MIN

PIN MATERIAL:
CP WIRE

CHECKER 张威超

0<L<4 ±0.1
4<L<16 ±0.2
16<L<50 ±0.3
PIN PITCH



DATE:
2008/07/08

DRAWING NO:

REV:
1.0

由 Autodesk 教育版产品制作

由 Autodesk 教育版产品制作