

型号

EFD-40-1

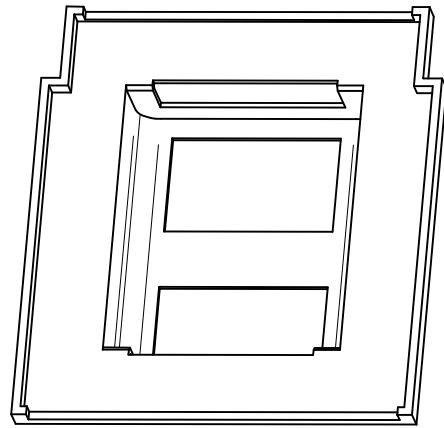
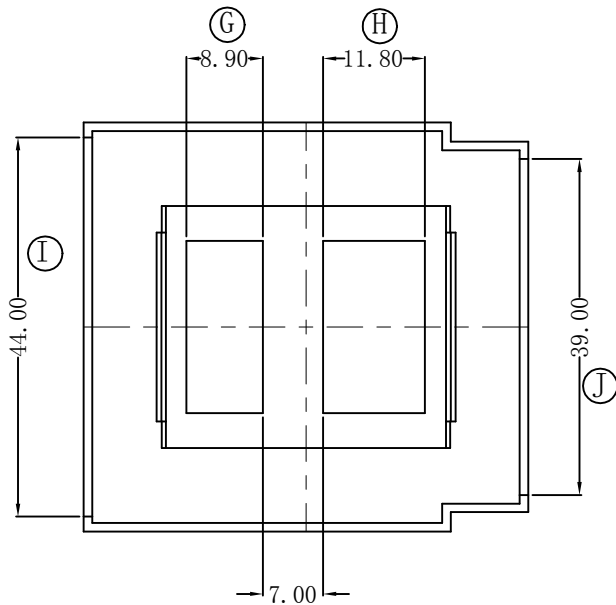
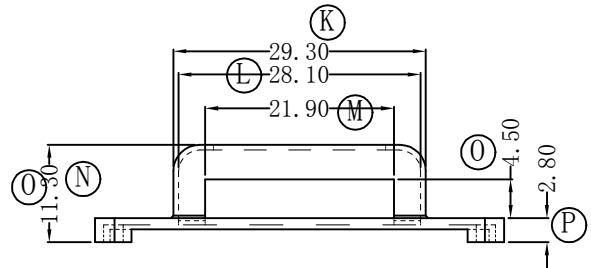
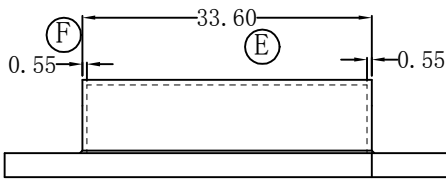
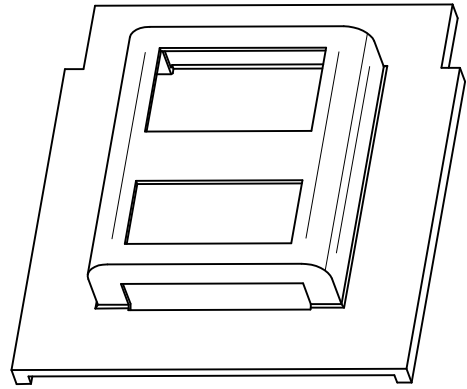
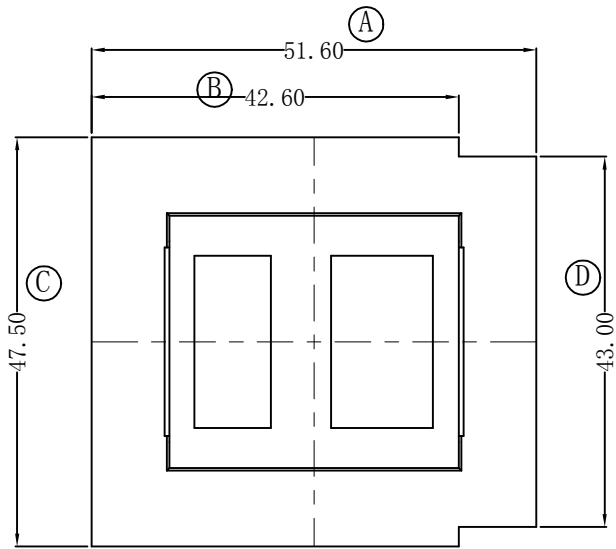

深圳市金辉鼎电子科技有限公司

地址: 深圳市光明街道将石社区油麻岗港深高新科技园
0755-27658768 传真 0755-27646486

ANGLE:
+/-1°

MODEL NAME:
EFD-40-1

UNIT:
mm

UL RECOGNITION:
UL 94V-0

BOBBIN MATERIAL:
PHENOLIC

DRAFTER

刘金

TOLERANCES

SCALE:
1/1

PIN TEN LOAD:
1.0 Kg MIN

PIN MATERIAL:
CP WIRE

CHECKER

张威超

0<L≤4 ±0.1
4<L≤16 ±0.2
16<L≤50 ±0.3
PIN PITCH ±0.20

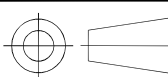

DATE:
2016/04/10

DRAWING NO:

REV:
1.0