

型号 PQ-3202

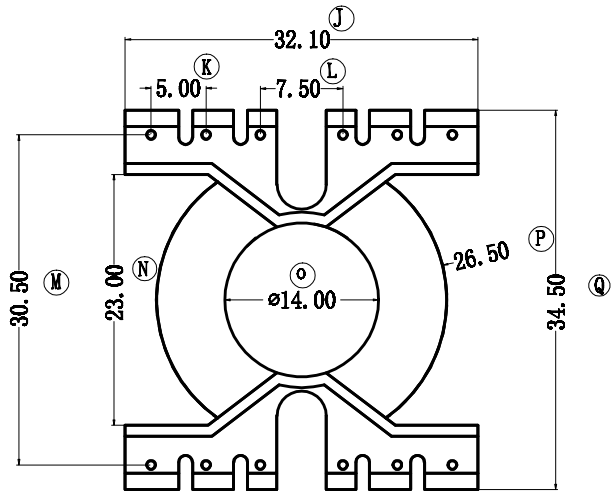
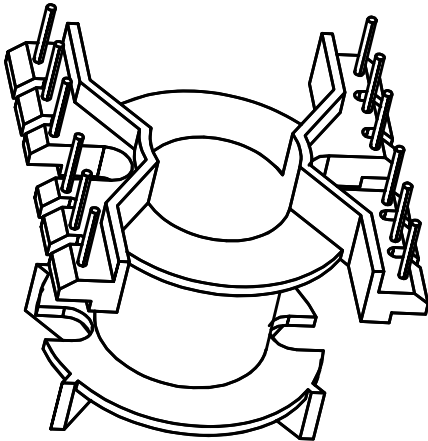
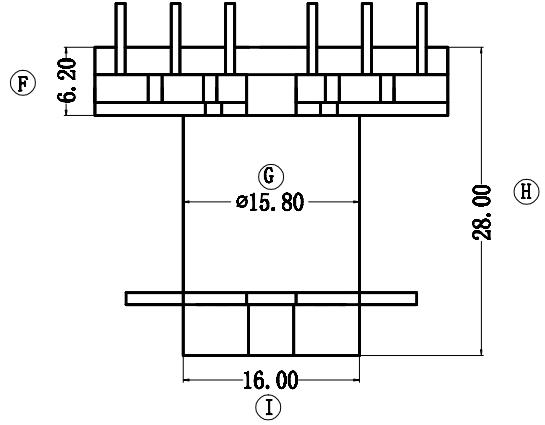
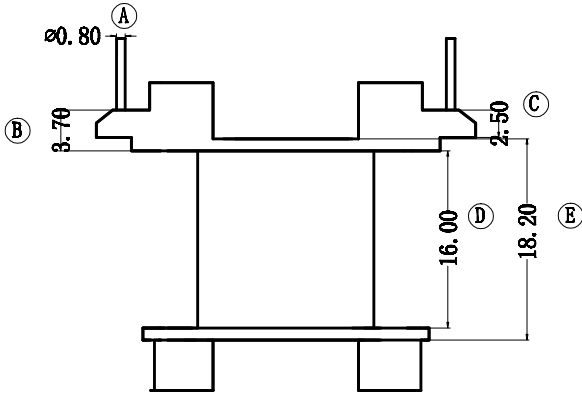

深圳市金辉鼎电子科技有限公司

ANGLE:  
+/-1°

MODEL NAME:  
PQ32 (6+6PIN)

地址: 深圳市公明街道将石社区油麻岗19号

UNIT:  
mm

UL RECOGNITION:  
UL 94V-0

BOBBIN MATERIAL:  
PHENOLIC

0755-27658768 传真 0755-27646486

DRAFTER

刘金

TOLERANCES

SCALE:  
1/1

PIN TEN LOAD:  
1.0 Kg MIN

PIN MATERIAL:  
CP WIRE

0<L<4 ±0.1  
4<L<16 ±0.2  
16<L<50 ±0.3  
PIN PITCH ±0.20

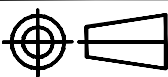

DATE:  
2012/04/01

DRAWING NO:

REV:  
1.0

CHECKER

张威超