

型号

RM-0602

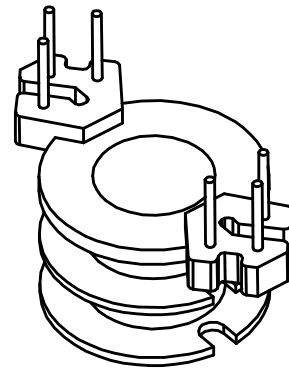
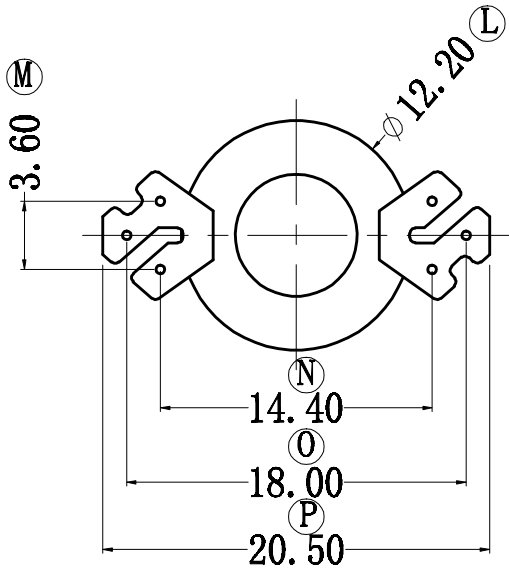
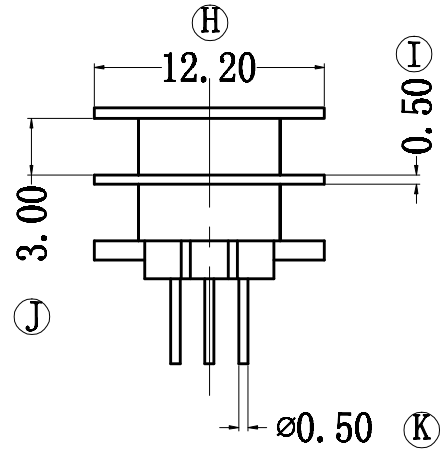
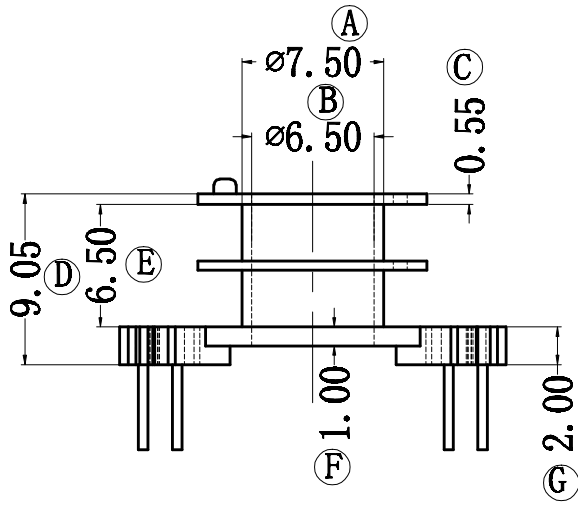

深圳市金辉鼎电子科技有限公司

ANGLE:  
+/-1°

MODEL NAME:  
RM06 (3+3PIN)

地址: 深圳市公明街道将石社区油麻岗19号

UNIT:  
mm

UL RECOGNITION:  
UL 94V-0

BOBBIN MATERIAL:  
PHENOLIC

0755-27658768 传真 0755-27646486

DRAFTER

刘金

TOLERANCES

SCALE:  
1/1

PIN TEN LOAD:  
1.0 Kg MIN

PIN MATERIAL:  
CP WIRE

0<L<4 ±0.1

4<L<16 ±0.2

16<L<50 ±0.3

PIN PITCH ±0.20

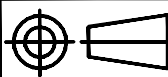

DATE:  
2012/12/03

DRAWING NO:

REV:  
1.0

CHECKER

张威超