

型号

RM-0802

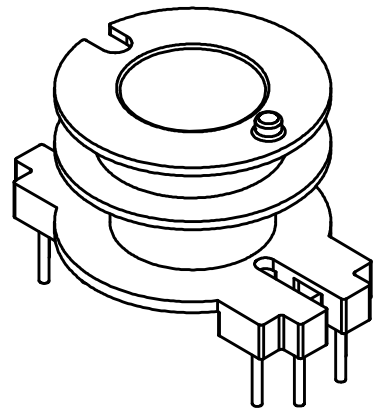
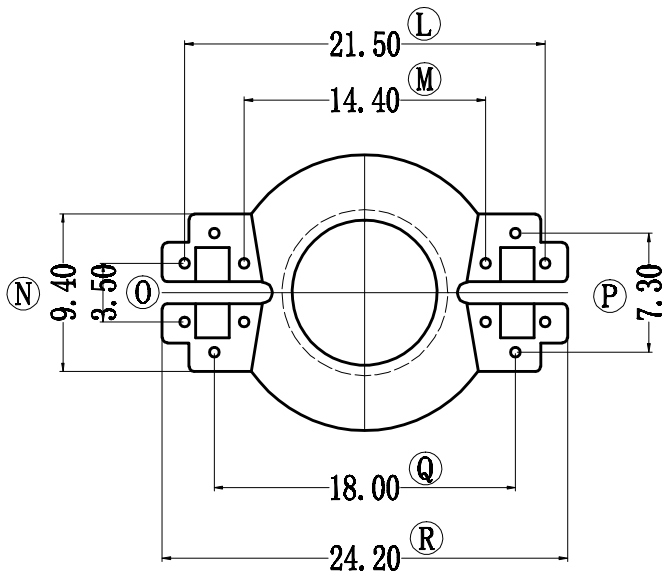
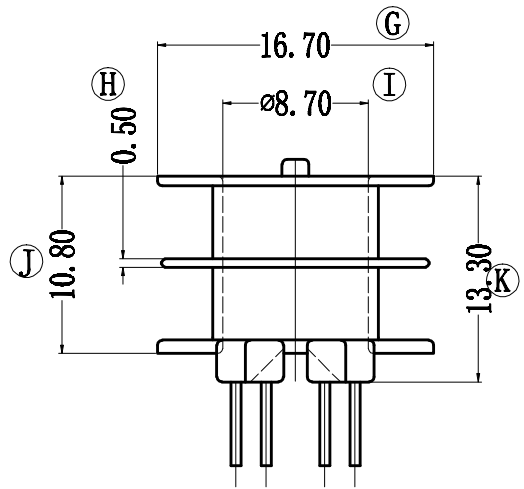
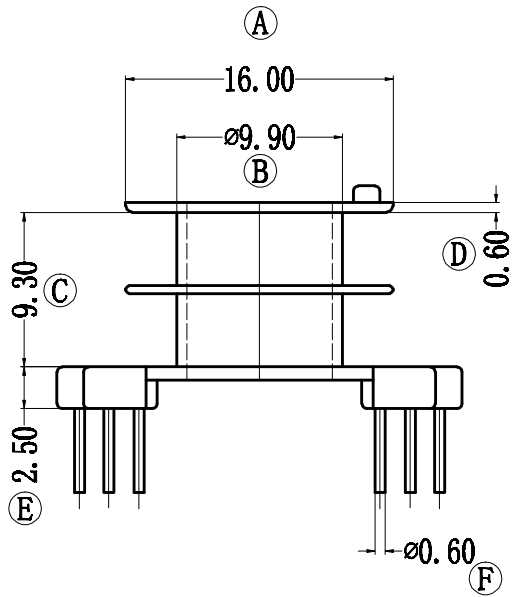

深圳市金辉鼎电子科技有限公司

地址: 深圳市公明街道将石社区油麻岗19号

0755-27658768 传真 0755-27646486

ANGLE:  
+/-1°

UNIT:  
mm

SCALE:  
4/1

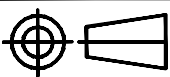

MODEL NAME:  
RM08 (6+6PIN)

UL RECOGNITION:  
UL 94V-0

PIN TEN LOAD:  
1.0 Kg MIN

DATE:  
2014/04/01

BOBBIN MATERIAL:  
PHENOLIC

PIN MATERIAL:  
CP WIRE

DRAWING NO:

REV:  
1.0

DRAFTER

刘金

CHECKER

张威超

TOLERANCES

0<L<4 ±0.1  
 4<L<16 ±0.2  
 16<L<50 ±0.3  
 PIN PITCH ±0.20