

型号

RM-1005

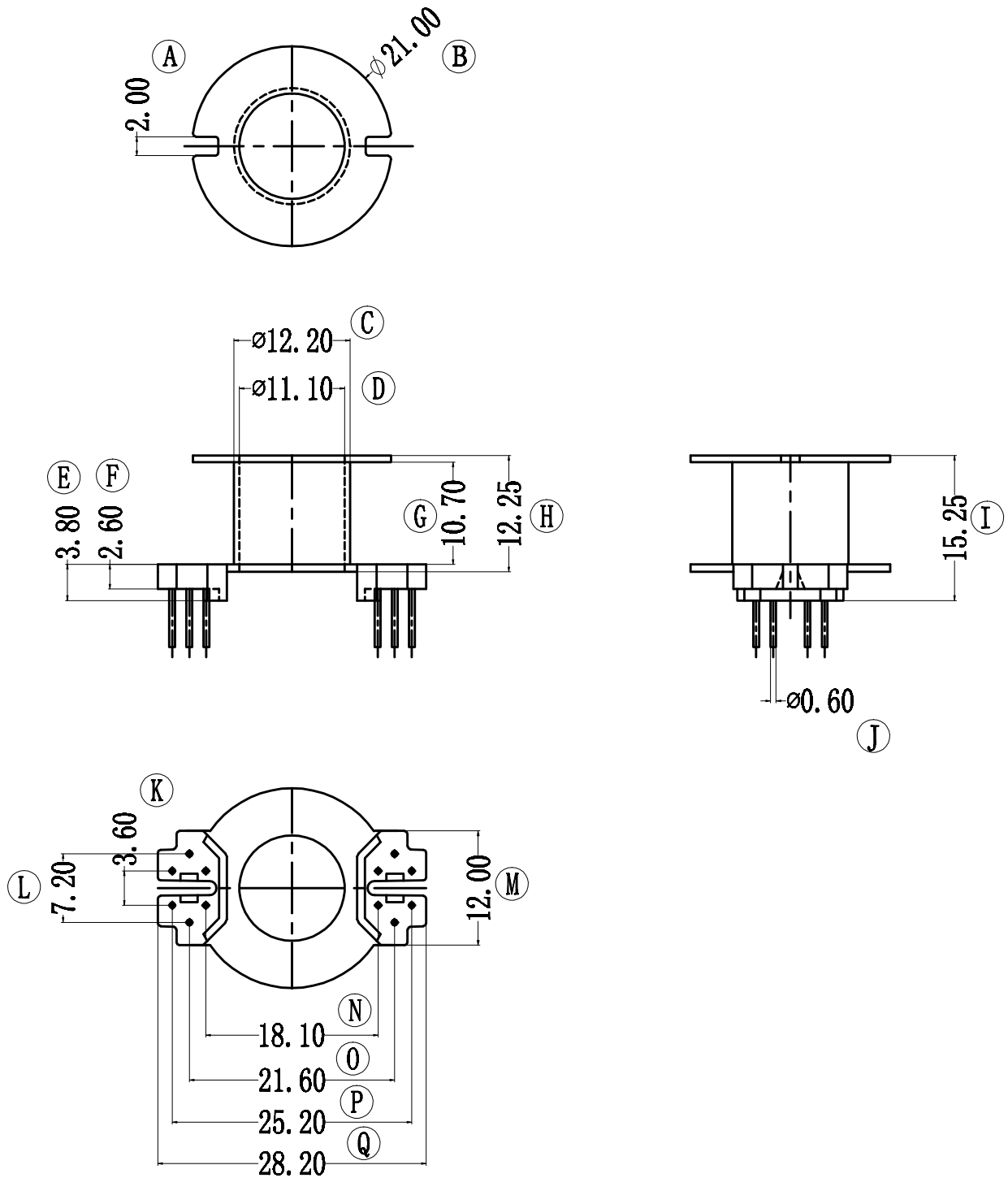

深圳市金辉鼎电子科技有限公司

地址: 深圳市公明街道将石社区油麻岗19号

0755-27658768 传真 0755-27646486

ANGLE:
+/-1°

MODEL NAME:
RM10 (6+6PIN)

UNIT:
mm

UL RECOGNITION:
UL 94V-0

BOBBIN MATERIAL:
PHENOLIC

DRAFTER

刘金

TOLERANCES

0<L<4 ±0.1
4<L<16 ±0.2
16<L<50 ±0.3
PIN PITCH ±0.20

SCALE:
4/1

PIN TEN LOAD:
1.0 Kg MIN

PIN MATERIAL:
CP WIRE

CHECKER

张威超

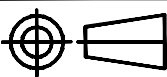

DATE:
2014/04/01

DRAWING NO:

REV:
1.0